

A Division of the Angelus Corporation
 Ph (262) 246-0500 Fax (262) 246-0450 www.picwire.com
 PO Box 330 Sussex, WI 53089

Approved : 

Date : 05/30/19

Rev. 0

Distribution : User

Uncontrolled if Printed

RJ45 Plug Connector (Shielded Cat 8)

For conductors with an insulation OD range of .039" - .063"

(For ANSI/TIA/EIA 568B Pin-Out Termination Only)

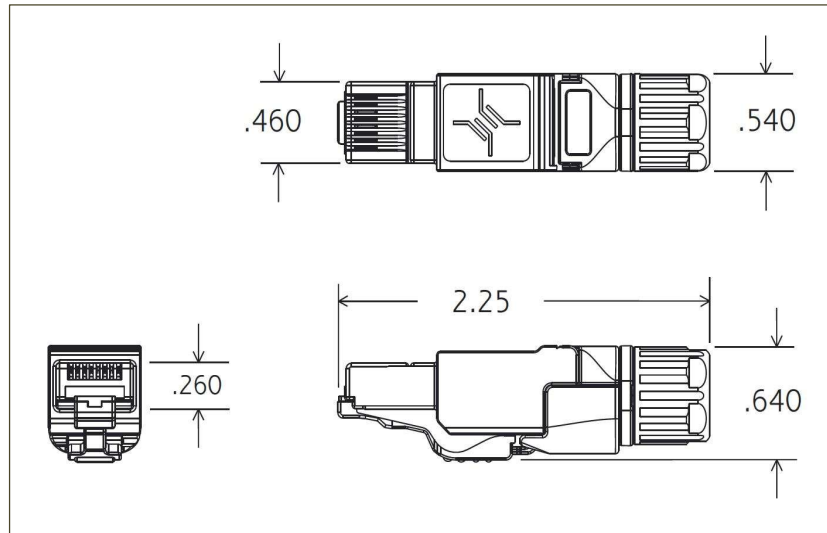

Not Shown : dust cap for RJ45 (removed upon installation)

PERFORMANCE

Category 8.1, 40 GBase-T

Current/Voltage: 1.0 Amps @ 30 VAC / 42 VDC

Contact Resistance: 20 milliOhms Max

ENVIRONMENTAL

Temperature Rating -40° C to +85° C

Insertion / Extraction 750 cycles min

CONNECTOR WEIGHT (Each)

0.83 ounces (23.59 grams)

RoHS COMPLIANT

Complies to RoHS Standards

REQUIRED TOOLING

PIC P/N 110701 Soft Jaw Clamping Pliers

Note: Similar Soft Jaw Pliers can be used

Notes:

(1) 2 pieces of Raychem ATUM heat shrink provided with connector for purpose of strain relief & moisture protection.

(2) Please refer to T-11112 Termination Instruction sheet for strip dimensions & instructions.

CONSTRUCTION

Materials:

Plug Housing	Zinc diecast
Contacts	Spring Steel
Contact Housing, Load Bar, Wire Carrier	Polycarbonate, UL 94-V0
RJ45 Latch, Dust Cap, Strain Relief Collett	Polybutylene Terephthalate, UL 94-V0
PCB	FR4, UL 94-V0
IDC Contacts	Phosphor Bronze
Shield Contact	Brass
Strain Relief (2)	ATUM Dual Wall Heat Shrink (MIL-DTL-23053/4, Class 3)

Finishes :

Contacts	Gold
Plug Housing, Shield Contact	Nickel
IDC Contacts	Tin

APPLICABLE STANDARDS

ISO/IEC 11801-1, DIN EN 50173-1, IEC 60603-7-81
 ANSI/TIA/EIA 568-C.2-1