



RUGGEDIZED HIGH-SPEED INTERCONNECT SOLUTION





ENGINEERED FOR MISSION-CRITICAL PERFORMANCE

MACHFORCE® connectors are advanced D38999-style 10G Ethernet solutions, specifically designed for high-speed aerospace and defense electronics utilizing SWaP/SWaP-C design principles. These connectors optimize performance while minimizing space and installation time. Built for mission-critical applications, they ensure maximum system uptime through their robust performance and ease of installation and field repair, making downtime a thing of the past.

APPLICATIONS:

- C5ISR
- Military
- Cyber Security
- Aerospace & Defense
- Artificial Intelligence
- Autonomous Weapons



High Speed Module Easy Access

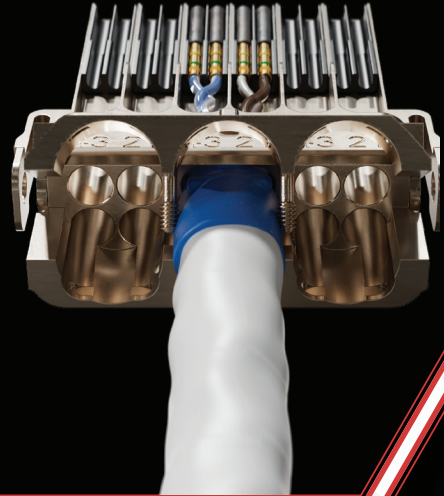

High Speed Module in Size 17 Straight Plug



High Speed Modules in 4 Port, 3 Port and 2 Port Offerings

Size 17 & Size 25 in Three Plating Options

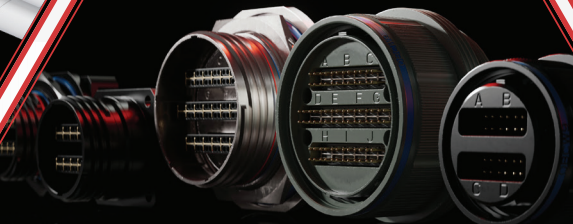

PCB Mounting

INNOVATIVE DESIGN FOR OPTIMAL PERFORMANCE

OUTSTANDING HIGH-SPEED PERFORMANCE

- **INNOVATIVE HIGH SPEED MODULE (HSM) DESIGN:** Our patented High Speed Module (HSM) in MACHFORCE connectors enhances signal integrity and maximizes data density with its linear configuration while providing easy access to every terminated pin for optimal performance and reliability.
- **REDUCED CROSSTALK:** The HSM's linear pattern provides better electrical performance due to reduced crosstalk and allows every twisted pair to maintain its twist right up to the pin or socket, further minimizing cross talk.
- **TRANSMITS MORE DATA IN LESS SPACE:** MACHFORCE's proprietary design maximizes port density and allows for 10 Ethernet ports in a size 25 housing and 4 ports in a size 17 housing without increasing your box size. The reduced number of connectors results in smaller, lighter and more compact final product.

SUPERIOR SIGNAL INTEGRITY AND RUGGEDIZED TECHNOLOGY

- **OPTIMIZED SIGNAL INTEGRITY:** MACHFORCE High-Speed Modules (HSM) enhance performance with their innovative design, minimizing crosstalk and delivering impeccable signal integrity. Pair with PIC E6A6824, E6A6826 or E74826 Ethernet cables for an extremely robust, high-speed data solution.
- **ROBUST PERFORMANCE:** MACHFORCE can withstand temperature extremes from -65°C to +200°C (depending upon plating option). Our backshells provide strain relief and ingress protection (IP67) against sand, dust and fluids, plus the anti-decoupling ring allows for secure connection in high shock and vibration environments.

ENHANCED PORT DENSITY TO MAXIMIZE YOUR SYSTEM'S POTENTIAL

- **INCREASE PORT DENSITY:** With up to 10 ports of 10G Ethernet, MACHFORCE reduces the need for multiple connectors, saving valuable space and weight in your designs.
- **COMPACT FOOTPRINT:** The advanced high-density configuration provides a more compact interconnect solution, ideal for optimizing space in complex projects.

DESIGN FLEXIBILITY WITH PORTFOLIO OPTIONS

- **VERSATILE CONFIGURATIONS:** MACHFORCE connectors provide versatility to fit any application. Choose from a full portfolio of sizes and configurations, including Flange, Plug, JamNut and PCB mounting options, plus three different platings: Olive Drab Cadmium and RoHS-compliant Black Zinc Nickel and Electroless Nickel!
- **COMPLETE BACKSHELLS OPTIONS:** Our selection of backshells supports various sealing and configuration needs, ensuring optimal performance for your specific requirements.

SIMPLIFIED INSTALLATION & MAINTENANCE

STREAMLINE ASSEMBLY WITH MACHFORCE

- **SIMPLIFIED INTEGRATION:** Designed with the end user in mind, MACHFORCE connectors facilitate easier terminations and are designed for any skill level technician.
- **DETAILED TERMINATION INSTRUCTIONS:** Follow our clear, step-by-step instructions to ensure reliable and successful terminations every time.
- **CERTIFIED ASSEMBLY SERVICES:** Streamline your project by leveraging our assembly services. Whether you're looking to save time or optimize resources, we provide expert assembly to ensure a seamless and efficient implementation process.

OPTIMIZE MAINTENANCE WITH MACHFORCE CONNECTORS

- **IN-FIELD REPAIRABILITY:** The linear design of the HSM provides direct access to each pin, enabling swift diagnostics and repairs on-site, ensuring minimal downtime and uninterrupted, mission-critical operation.
- **STANDARD TOOLING:** MACHFORCE connectors can be terminated and repaired using standard tools, saving time and eliminating the hassle of procuring specialty equipment.
- **QUICK REPAIRS:** Repair a single faulty pin or re-terminate a port within minutes without affecting other pins. MACHFORCE connectors use industry-standard 22D pins and sockets, ensuring you can complete repairs on-the-spot without complicated procedures.
- **DEMONSTRATION VIDEOS:** Access our demo videos for guidance on performing field repairs, including single pin fixes and full port re-terminations.

TERMINATE HSM WITH STANDARD TOOLING!

1. Crimp Tool, M22520/2-01
2. Positioner, M22520/2-06
3. Positioner, M22520/2-09
4. Tweezers
5. Small Scissors
6. Needle Nose Pliers
7. Calipers 12"
8. Picking Tool
9. Allen Key 0.05"
10. Small Flush Cut Wire Cutter
11. Ideal 55-1773 Ergo-Elite Stripmaster, or Equivalent
12. Razorblade

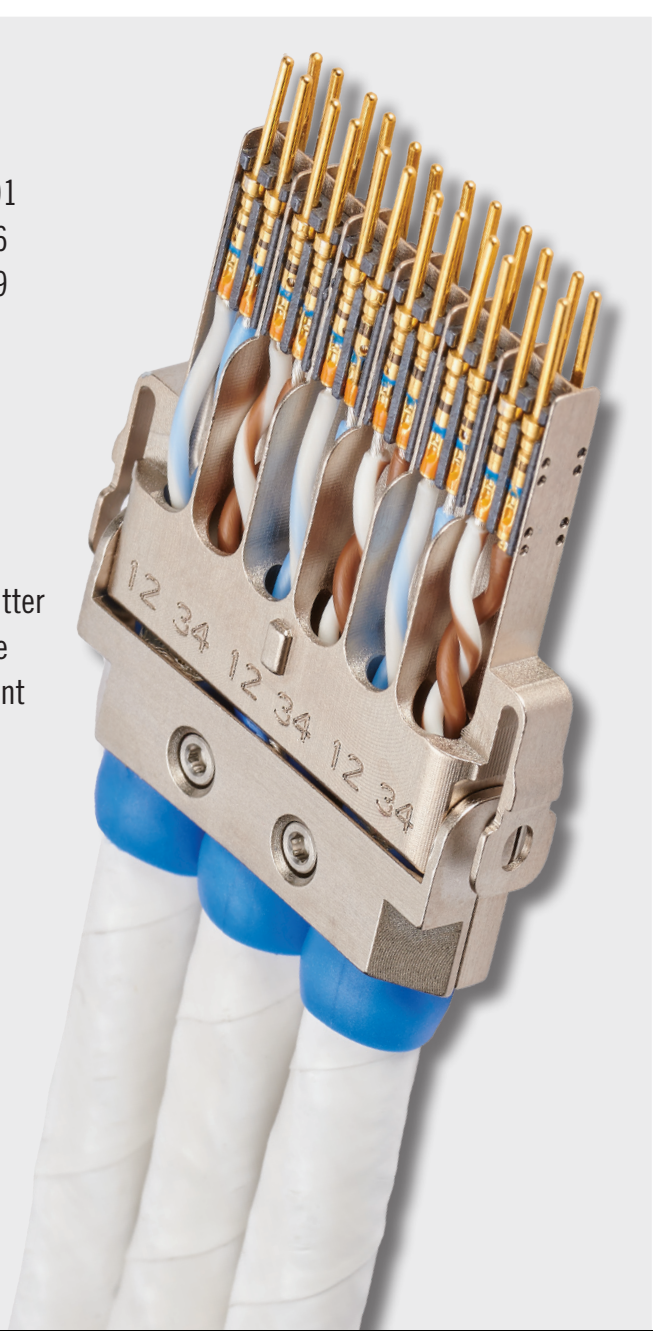

**USES
STANDARD
TOOLING!**

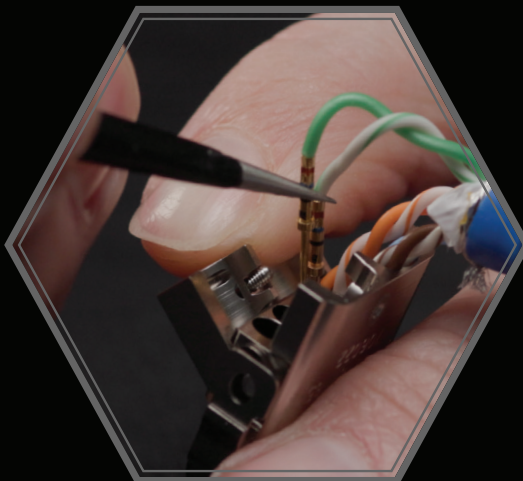
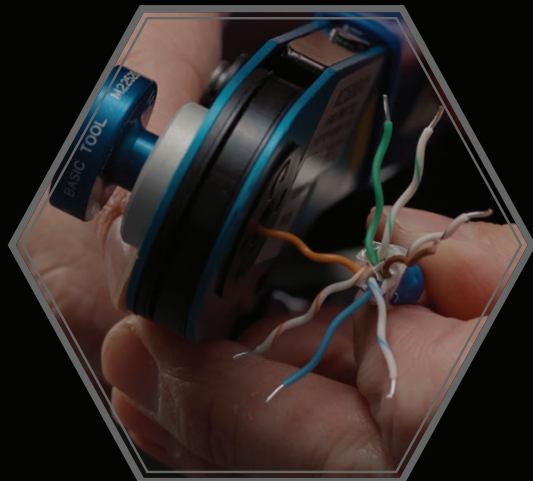

EXPERT SUPPORT - EVERY STEP OF THE WAY

EXPERT GUIDANCE

With PIC Wire & Cable, you're not just getting another product—you're gaining a partner dedicated to your success. From customizable solutions to tailored assistance, we're dedicated to ensuring your success with MACHFORCE connectors. Our team ensures you have everything you need to navigate every stage of your project smoothly and effectively.



DEDICATED TEAM:

With PIC, you have a trusted advisor by your side, offering technical guidance and expertise throughout the interconnect design process.



RESPONSIVE SUPPLIER SUPPORT:

We're here to assist with any questions or issues, providing a seamless experience throughout your project.

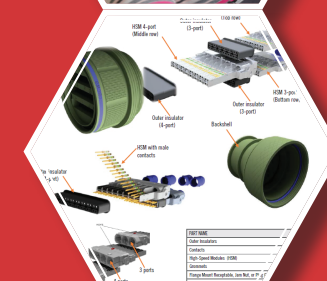

COMPREHENSIVE RESOURCES:

Access detailed termination instructions, technical articles, and additional training upon request to fully leverage the capabilities of MACHFORCE connectors.



ASSEMBLY SOLUTIONS:

Streamline your project by leveraging our assembly services. Whether you're looking to save time or optimize resources, we provide expert assembly to ensure a seamless and efficient implementation process.



CUSTOMIZABLE SOLUTIONS:

Whether you need individual connectors or complete assemblies, MACHFORCE offers a part number builder and a range of components to suit your specific requirements.

SUPERIOR PERFORMANCE

SHIELDED 10G ETHERNET CABLE SOLUTIONS

MACHFORCE connectors have been tested and qualified with PICMates 10G Ethernet cables. The E6A6824 and E6A6826 CAT6a cables minimize crosstalk between twisted pairs. These cables feature silver-plated copper braided shielding and foil shielding that reduce electromagnetic waves emitted from the pairs. When the MACHFORCE connector is paired with E6A6824 and E6A6826 cables, the resulting electrical performance allows for industry-leading cable lengths and multiple connection breaks.

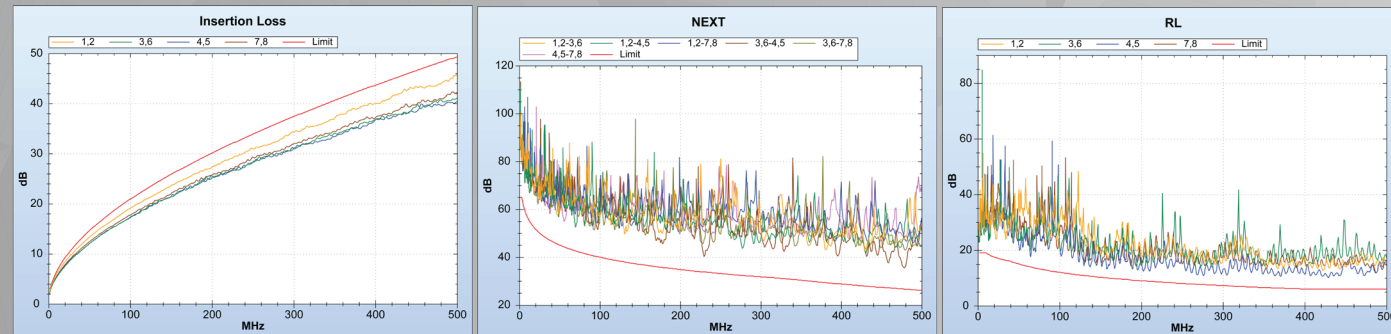
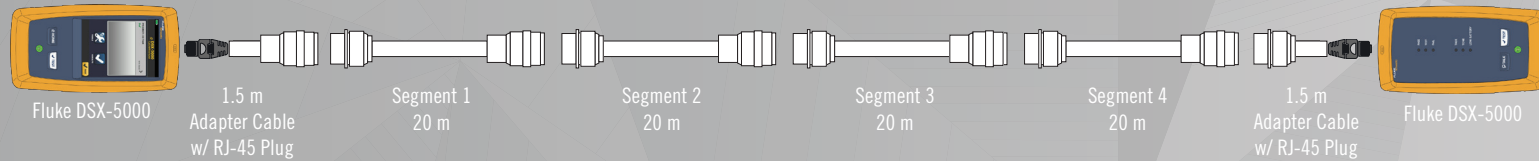

*E6A6824 electrical performance over 80M with 6.4dB of headroom

PIC® Wire & Cable expands its MACHFORCE Connectors line with two new RoHS-compliant platings—Black Zinc Nickel and Electroless Nickel—boosting durability and global compliance for mission-critical aerospace and defense applications, while still meeting the same Cat6a performance as the existing Olive Drab Cadmium plating option.

PLATING CHART



D38999 TESTING CRITERIA

	PLATING	ROHS COMPLIANT	CORROSION RESISTANCE	TEMPERATURE CYCLING
NEW	Black Zinc Nickel	Yes	500hr Dynamic Salt Spray Test	-65°C to +175°C
NEW	Electroless Nickel	Yes	96hr Standard Salt Spray Test	-65°C to +200°C
	Olive Drab Cadmium	—	500hr Dynamic Salt Spray Test	-65°C to +175°C



Explore our online part builder: scan the QR code to begin. Choose your project options and request a quote effortlessly.

PART NUMBER BUILDER

CONNECTOR

SAMPLE PART NUMBER: **MF** **3825** **F** **S** **W** **N** - **EC**

PRODUCT	MF Family: MACHFORCE								
SHELL TYPE	3825 D38999 – Size 25	3817 D38999 – Size 17							
SHELL STYLE	F Flange Mount*	P Straight Plug	J Jam Nut						
CONTACT	S Sockets (F or J Shell Style)	P Pin (Plug Only)							
PLATING	W Olive Drab Cadmium	Z Black Zinc Nickel	R Electroless Nickel						
KEY POSITION	N 80	L 142	M 196	N 293	C 66	L 140	M 200	N 257	
DETAIL	A 135	170	200	310	D 62	145	180	280	
	B 49	169	200	244					
CABLE TYPE	EC 24 AWG Ethernet (E6A6824)	PC1 PCB Mount (F or J Style)							
	ED 26 AWG Ethernet (E6A6826) (E74826)								

*Contact PIC Wire & Cable if you may need Size 25 mounting nut plates

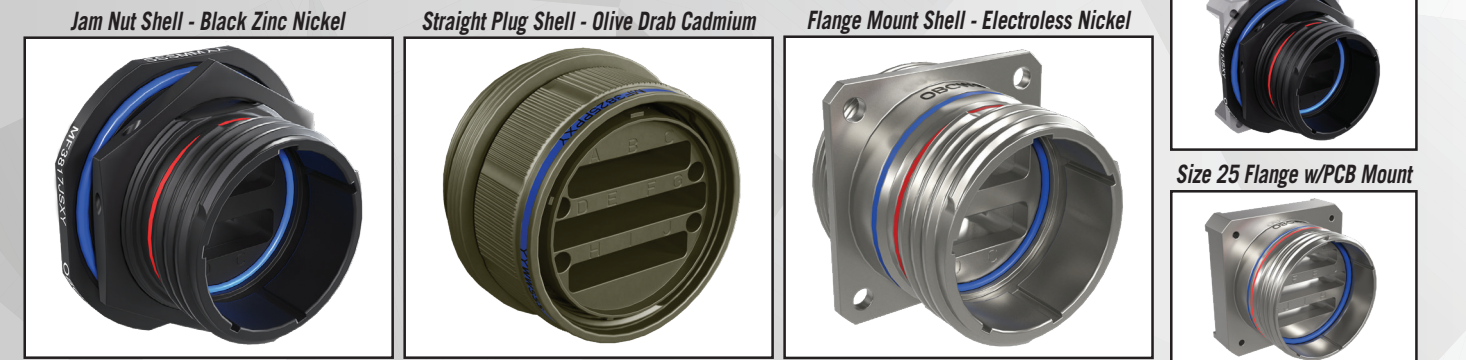

BACKSHELL

SAMPLE PART NUMBER: **MF** **3825** **SP** **W** **S** **BC**

PRODUCT	MF Family: MACHFORCE								
SHELL TYPE	3825 D38999 – Size 25	3817 D38999 – Size 17							
STYLE	SP Standard Profile Sealed	LP Low Profile Unsealed							
PLATING	W Olive Drab Cadmium	Z Black Zinc Nickel	R Electroless Nickel						
ANGLE	S Straight	R Right Angle (SP Style, 3817 Shell Type Only)							
CABLE TYPE	BC 24 AWG Ethernet (E6A6824)	BD 26 AWG Ethernet (E6A6826) (E74826)							

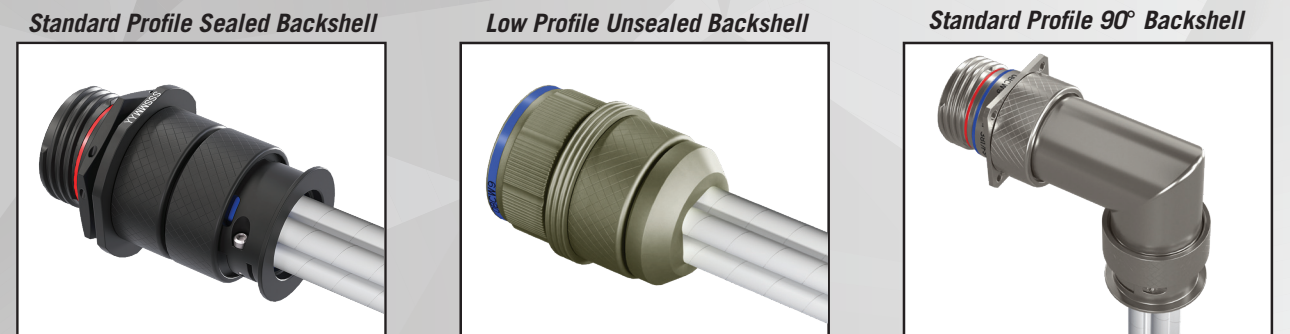

The 90° backshell does not support E74826

For those with specific or unique applications, MACHFORCE is offered as a complete assembly for your customization needs. For customized configurations, contact PIC Wire & Cable.

SIZE 17 DIMENSIONS

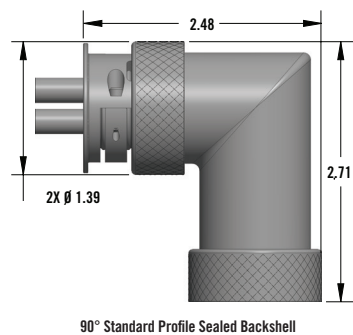
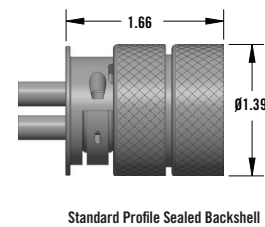
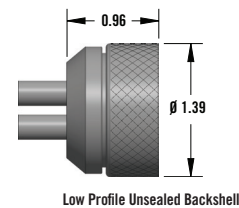
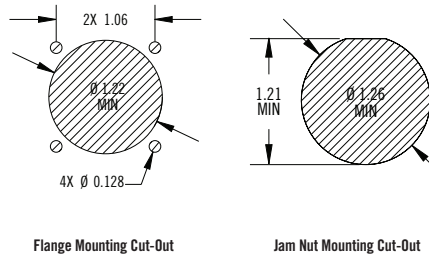
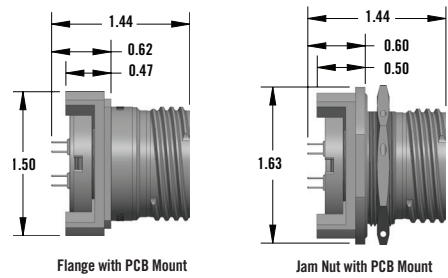
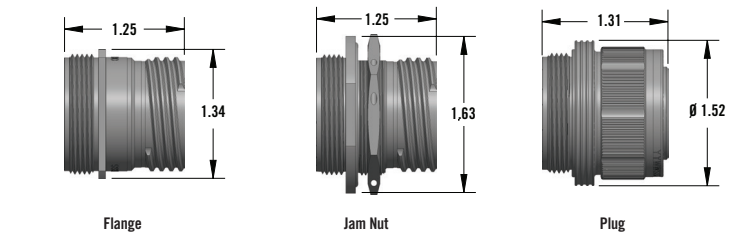

SHELL

- **Type:** D38999 Series III Style
- **Styles:** Flange, Jam Nut, & Plug
- **Max. Clearance Panel Thickness:**
Flange: 0.228" (5.79mm)
Jam Nut: 0.126" (3.20mm)

MATERIALS

- **Body Components:** Aluminum
- **ADR Ring:** Stainless Steel

WEIGHT

- **Flange:** 0.10lbs (45.4g)
- **Jam Nut:** 0.11lbs (49.9g)
- **Plug:** 0.16lbs (72.6g)
- **PCB:** 0.17lbs (77.1g)
- **Standard Backshell:** 0.09lbs (40.8g)
- **Low Profile Backshell:** 0.04lbs (18.1g)
- **90° Backshell:** 0.11lbs (49.9g)

CONTACTS

- M39029/58-360 & M39029/57-354

COUPLING TORQUE

- **Max. Engagement & Disengagement:** 24 in-lb (2.7 Nm)
- **Min. Disengagement:** 3 in-lb (0.34 Nm)

All dimensions are in inches unless otherwise specified.

SIZE 25 DIMENSIONS

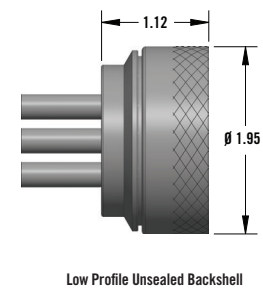
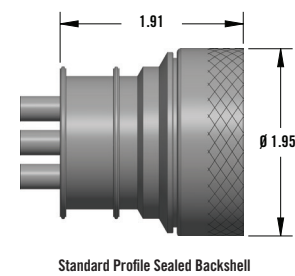
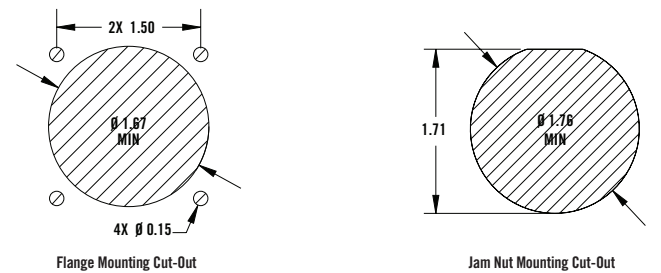
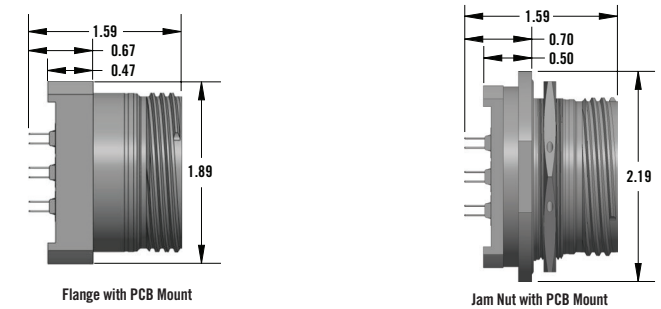
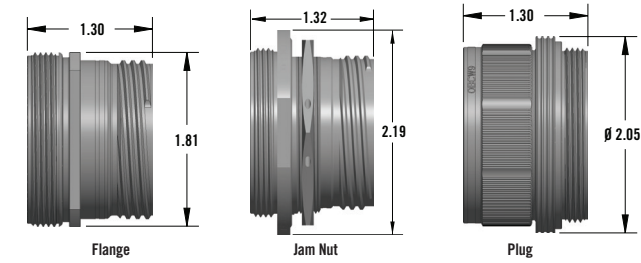

SHELL

- **Type:** D38999 Series III
- **Styles:** Plug, Flange & Jam Nut
- **Max. Clearance Panel Thickness:**
Flange: 0.197" (5.00mm)
Jam Nut- PCB Mount: 0.126" (3.20mm)

MATERIALS

- **Body Components:** Aluminum
- **ADR Ring:** Stainless Steel

WEIGHT

- **Flange:** 0.17lbs (77.1g)
- **Jam Nut:** 0.15 lbs (67.1g)
- **Plug:** 0.27lbs (122.5g)
- **Standard Backshell:** 0.12lbs (54.4g)
- **Low Profile Backshell:** 0.08lbs (36.2g)
- **PCB:** 0.21lbs (95.3 g)

CONTACTS

- M39029/58-360 & M39029/57-354

COUPLING TORQUE

- **Max. Engagement & Disengagement:** 40 in-lb (4.5 Nm)
- **Min. Disengagement:** 5 in-lbs (0.56 Nm)

All dimensions are in inches unless otherwise specified.

LET PIC WIRE & CABLE FIND SOLUTIONS FOR YOUR TOUGHEST CONNECTIVITY CHALLENGES



W220 N1051 Springdale Rd.
Waukesha, WI 53186

Phone: 262.246.0500
Toll Free: 800.742.3191
Sales@theangeluscorp.com
www.PICwire.com

CONTACT US ON



MACHFORCE

PIC Wire & Cable is your premier aerospace and defense connectivity expert, delivering comprehensive, innovative interconnect solutions engineered to enhance the performance of mission-critical avionics systems. For over 50 years, we've worked side-by-side with clients to solve challenging problems and integrate those engineered solutions into aircraft worldwide. This is what we do—we're here to make our customers' jobs easier. We are committed to providing high-quality service, premium products and superior solutions to the aerospace and defense industries. Make PIC your go-to for aerospace cabling solutions and you'll see why we've been trusted with some of the toughest jobs in the industry.